

• PLAN •

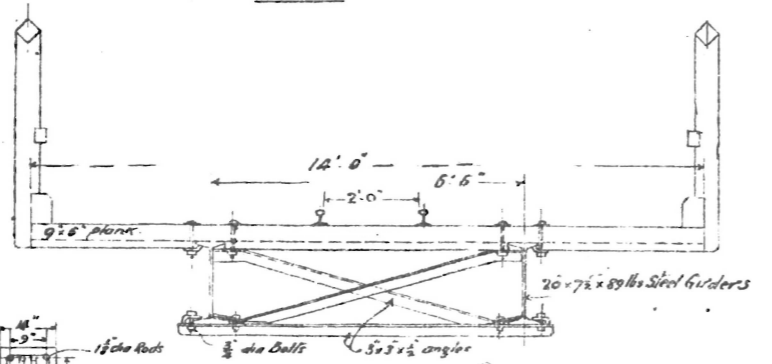

• SECTION OF HEADSTOCK AT A.A.

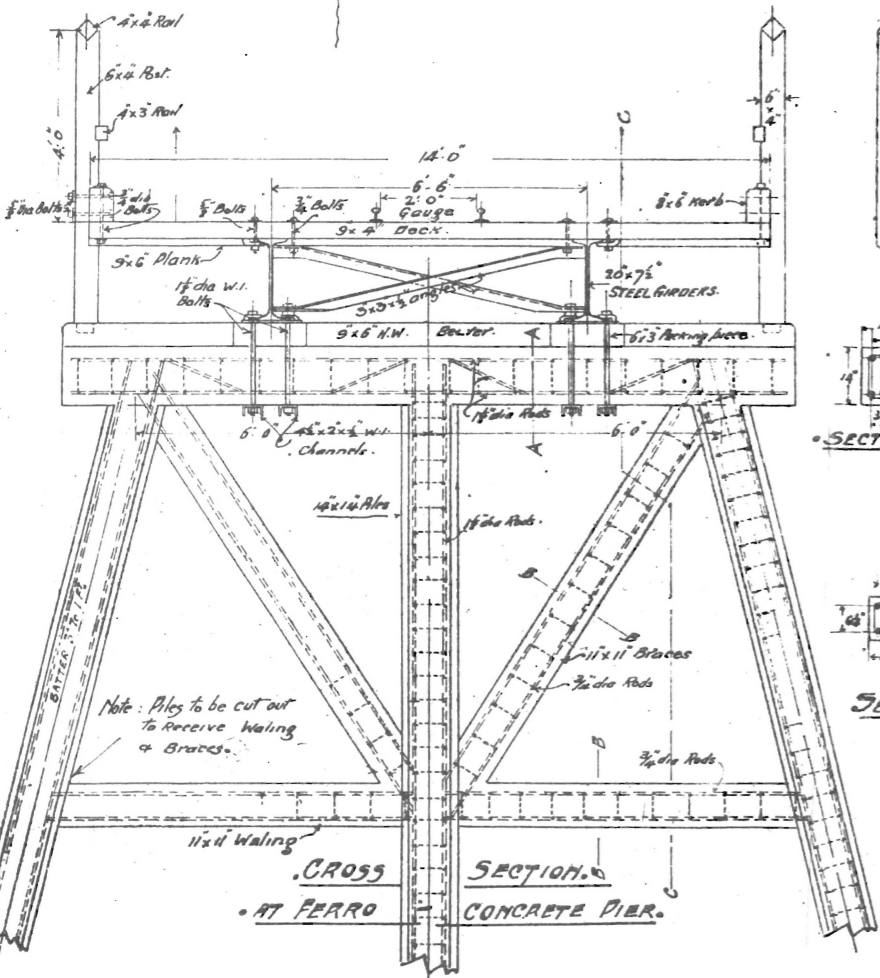
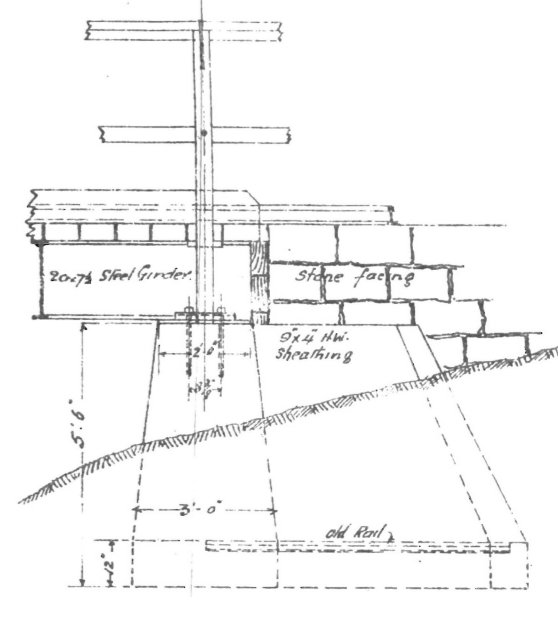
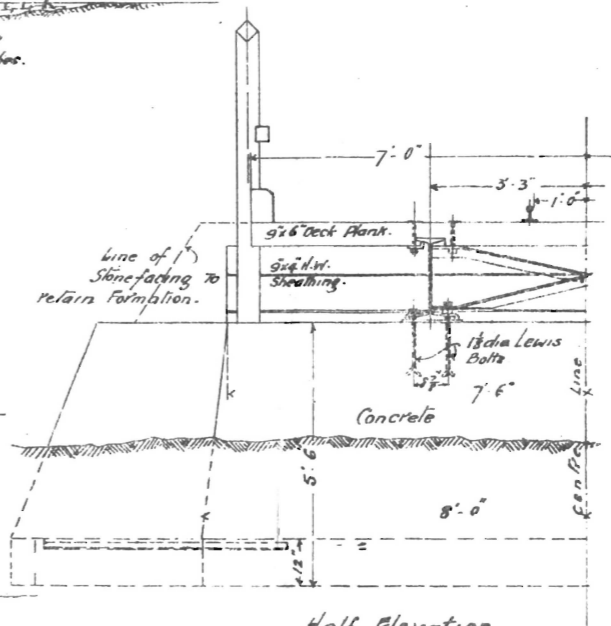
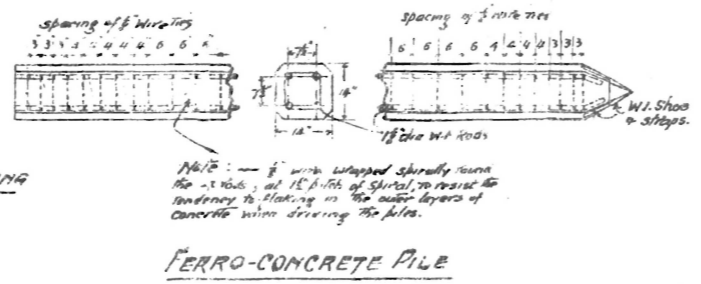
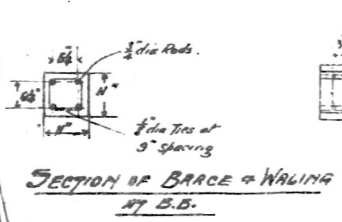
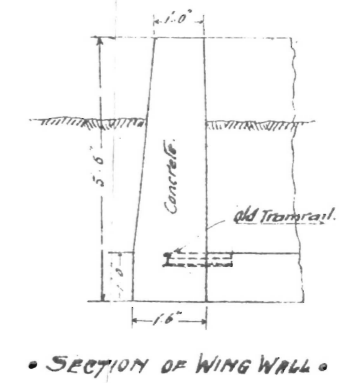
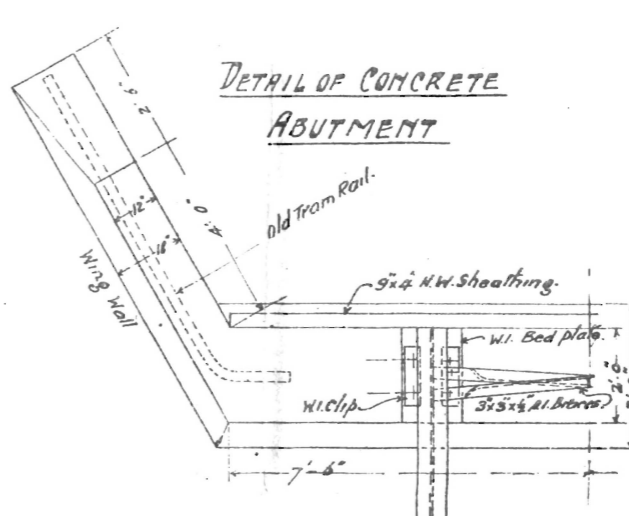
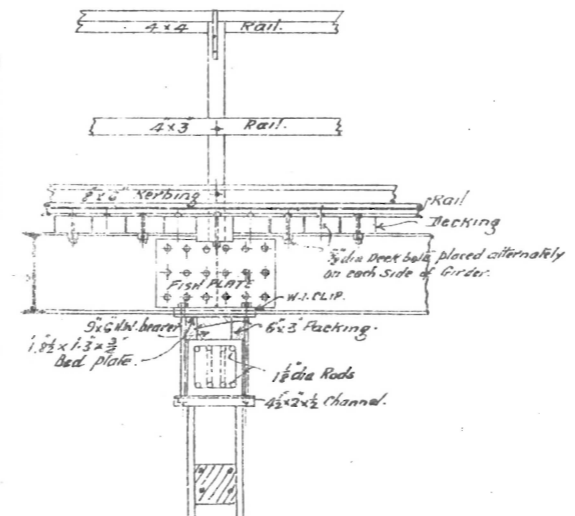

Item	Quantity	Order No.	Date
Removal Rep'd Mats			
Steel girders from England to Telegraph	Order	15.11.05	
Wrought C.I. Work	Pymont Order No 630	22.1.06	
Timber	J.J. Witney Order No 493	23.2.04	
Ferro-Concrete piles	Ordered by Parawai from Lautoka	4/20 4/25	
18 dia Rods & wires for waling and braces	J.J. Witney Order No 504	6.3.06	

NOTE: For details of Wrought and C.I. Work See Plan No 8507

• TEIDAMU RIVER BRIDGE •
 • BA-LAUTOKA LINE •
 • CS&GL^Y FIJI •